

Specifications of timber used. All sizes are nominal (before machining) unless otherwise stated.

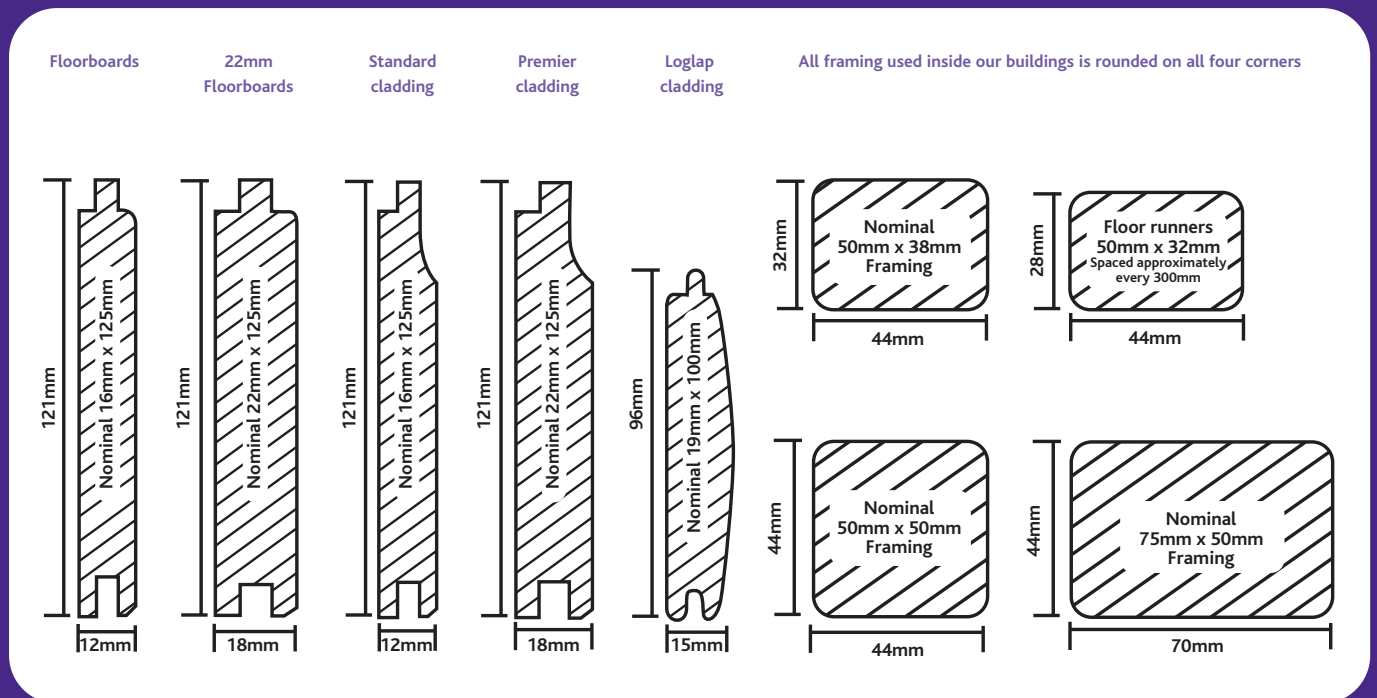

The finished sizes of our product are accurate to +/- 1mm.

PLEASE NOTE:

Buildings are available in all timber specifications and can be manufactured to your individual requirements. All measurements in the brochure are internal eaves and ridge height and for planning application purposes, the external measurements including roof and floor joists will be required.

QUALITY BUILT TO LAST

Approved agent, stockist and distributor for Timber Garden Buildings Limited.

All contents of this brochure including photographs can only be reproduced with written permission and prior consent from Timber Garden Buildings Limited.



TGB sheds

SCOTLAND

TIMBER GARDEN BUILDINGS | QUALITY BUILT TO LAST

STORAGE
AND
KENNELS



SHEDS

SUMMERHOUSES



PLAYHOUSES



contents

sheds	4	4	5	5
6	7	8	8	9
9	10	11	11	12
12	13	13	14	14
15	16	storage & kennels	17	17
18	18	19	19	19
20	20	21	summer houses	22
23	24	25	26	27

contents



4 Superior Apex	17 Garden Store	32 Corner Summer House Georgian
4 Standard Apex	17 Garden Tidy	33 Corner Summer House Leaded
5 Superior Pent	18 Garden Chest	34 Blenheim Corner Summerhouse
5 Standard Pent	18 Wheelie Bin Store	35 Pavilion
6 Hipex	19 Dog Kennel	36 Pent Summer House
7 Cabin	19 Animal Arc	37 Dual Pent Summerhouse
8 Bentley Supreme Apex	19 Deluxe Apex Kennel and Run	38 Octagonal 8 and 10
8 Bentley Supreme Pent	20 Pent Kennel and Run	39 Stretched Octagonal 8
9 Potting Shed	20 Hen House	40 Sandringham
9 Combi-Potting Shed	21 Traditional Dutch Barn	41 Toddlers Retreat
10 Sunflower	22 Summer Cabin	42 My Little Den
11 Security Apex	23 Althorpe	43 Ladybird Cottage
11 Security Pent	24 Ascot	44 Snowdrop Cottage
12 Heavy Duty Apex	25 Balmoral	45 Escape
12 Heavy Duty Pent	26 Chatsworth	46 Wilton Lodge
13 Garage Apex and Pent	27 Buckingham	47 Candy Cabin
14 Rhino Apex	28 Windsor	48 The Hideaway
14 Rhino Pent	29 Kensington	49 Charleys Castle
15 Groundsman	30 Wentworth	50 Kids Club House
16 Corner Cabin	31 The Elton Home Office	

PLEASE NOTE: All our playhouses conform to trading standards BS5665 and are fitted with the CE mark
 Safety features include: acrylic safety glass with planed and rounded corners on all the framing, staircases with horizontal tread, and hand rails. Doors are fitted with anti trap plastic strip to prevent finger injury.

introduction

At Timber Garden Buildings Ltd we manufacture a comprehensive range of quality garden buildings. We take great care and pride in our attention to detail and feel confident you will find a product suitable for your needs. Many options are available for all our buildings, these include; 22mm floorboards, 22mm premier cladding, 19mm log effect cladding, security products, 38mm x 50mm framing as standard, 50mm x 50mm and 50mm x 75mm framing, additional doors and windows, and increased eaves heights. If you cannot find a building to suit your needs please enquire about a custom built model as we cater for our customer needs.

We are a progressive forward thinking company and in-line with our policy of continual development and improvement reserve the right to change specifications, designs and prices without notice.

All buildings are pre-treated with quality water based wood preservative prior to delivery. To ensure longevity we recommend a top coat upon installation, and annually thereafter. Timber is a natural product, subject to changes caused by environmental conditions, to minimise contraction and expansion it is essential to maintain your building.

All timber sizes are nominal, before machining unless stated.

All building dimensions shown are approximate, based on external wall sizes, allowances should be made for roof overhangs when locating your building in a confined space.

All glass used is 3mm horticultural unless otherwise stated.



QUALITY BUILT TO LAST



**SUPERIOR APEX
STANDARD FEATURES**

Fully tongue and grooved construction
 Door can be positioned on any side or end wall
 Lugged and braced door
 Lock and key
 Interchangeable panels

SPECIFICATION

Sizes from:
 1.22m x 1.22m (4' x 4') up to
 3.66m x 2.44m (12' x 8')
 Superior Eaves Height 1864mm
 Superior ridge Height
 4' - 86" / 2190mm
 5' - 89" / 2260mm
 6' - 92" / 2336mm
 8' - 97" / 2475mm
 Door 1880mm x 762mm
 Windows 610mm x 457mm
 Framing 38mm x 50mm
 Cladding 16mm x 125mm

OPTIONS AVAILABLE

22mm premier cladding
 19mm Log Lap cladding
 22mm floor boards
 50mm x 50mm framing
 Security options
 Opening window
 Felt options

Superior &
Standard Apex

**STANDARD APEX
STANDARD FEATURES**

Fully tongue and grooved construction
 Lugged and braced door
 Lock and key
 Interchangeable panels

SPECIFICATION

Sizes from:
 1.22m x 1.22m (4' x 4') up to
 3.66m x 2.44m (12' x 8')
 Standard eaves ht. 1680mm
 Standard ridge ht.
 4' - 78" / 1985mm
 5' - 81" / 2050mm
 6' - 85" / 2160mm

8' - 90" / 2280mm
 Door 1765mm x 762mm
 Windows 610mm x 457mm
 Framing 38mm x 50mm
 Cladding 16mm x 125mm

OPTIONS AVAILABLE

22mm premier cladding
 19mm Log Lap cladding
 22mm floor boards
 50mm x 50mm framing
 security options
 opening window
 Stable Door
 Felt options



Standard Apex -
 If door option B,C or D are chosen then the height of the door is reduced by 190mm to 1575mm x 762mm.

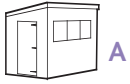

A

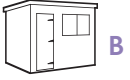

B



C



D



E



V



W



X



Y



Z



**SUPERIOR PENT
STANDARD FEATURES**

3" x 2" Framed roof
Fully tongue and grooved construction
Door can be positioned on any side or end wall
Lock and key

SPECIFICATION

Sizes from:
1.22m x 1.22m (4' x 4') to
3.66m x 2.44m (12' x 8')
Eaves ht. 1937mm
Ridge ht. 2153mm
Door 1880mm x 762mm
Windows 610mm x 457mm
Framing 38mm x 50mm
Cladding 16mm x 125mm

OPTIONS AVAILABLE

22mm premier cladding
19mm Log Lap cladding
22mm floor boards
50mm x 50mm framing
Security options
Felt options

**Superior &
Standard Pent**

**STANDARD PENT
STANDARD FEATURES**

3" x 2" Roof
Fully tongue and grooved construction
Door can be positioned on any side or end wall
Lock and key

SPECIFICATION

Sizes from:
1.22m x 1.22m (4' x 4') to
3.66m x 2.44m (12' x 8')
Eaves ht. 68" / 1737mm
Ridge ht. 76" / 1953mm
Door (front) 1765mm x 762mm
Door (to 4ft end) 1690mm x 762mm

Windows 610mm x 457mm
Framing 38mm x 50mm
Cladding 16mm x 125mm

OPTIONS AVAILABLE

22mm Premier cladding
22mm Floorboards
50mm x 50mm Framing
Security features





Hipex

STANDARD FEATURES

Fully tongued and grooved construction
 Door can be positioned on front or either end wall
 Ledged and braced door
 Lock and key

SPECIFICATION

Sizes from 2.44m x 1.83m (8' x 6') up to 3.66m x 2.44m (12' x 8')
 Eaves height 1.964m
 Ridge height
 4' – 90" / 2290mm
 5' – 93" / 2360mm

6' – 96" / 2436mm
 8' – 101" / 2575mm
 Door 1765mm x 762mm
 Windows 610mm x 457mm
 Framing 38mm x 50mm
 Cladding 16mm x 125mm

OPTIONS AVAILABLE

50mm x 50mm framing
 22mm Premier Cladding
 19mm Log Lap Cladding
 22mm Floor boards
 Security options
 Stable door
 Felt options



Cabin

STANDARD FEATURES

Front and side fixed windows
Roof overhang 1' or 300mm
Central door

SPECIFICATION

Sizes from:
1.52m x 2.13m (5' x 7') up to
2.44m x 3.05m (8' x 10')
Eaves ht. 1680mm
Ridge ht. 6' - 85" / 2160mm
7' - 89" / 2270mm
8' - 90" / 2280mm
10' - 93" / 2370mm
Door 1765mm x 762mm

Windows 610mm x 457mm
Framing 38mm x 50mm
Cladding 16mm x 125mm

OPTIONS AVAILABLE

50mm x 50mm framing
22mm premier cladding
19mm Log Lap cladding
22mm floor boards
2'6" or 4' verandah
Security options
Stable door
Felt options

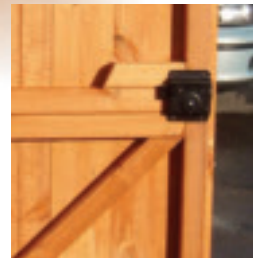

Bentley's Supreme Apex and Pent

PENT



BENTLEY'S SUPREME APEX STANDARD FEATURES

Diagonal bracing in the sides
Diagonal bracing in the ends
38mm x 50mm boxed framed door
6'2" High door (available in either end)
Standard press lock and key
Zinc plated hinges
3 fixed windows

SPECIFICATION – Bentley Supreme Apex

Sizes from 2.44m x 1.83m (8' x 6') up
to 3.66m x 2.44m (12' x 8')
Eaves height 5'10" / 1778mm
Ridge height
4' – 81" / 2078mm
5' – 84" / 2143mm

6' – 88" / 2253mm
8' – 93" / 2373mm
Door 1778mm x 914mm
Windows 610mm x 457mm
Framing 38mm x 50mm
Cladding 16mm x 125mm

OPTIONS AVAILABLE - Bentley Supreme Apex and Pent

22mm Premier Cladding
19mm Log Lap Cladding
22mm Floor boards
Increased height options which
enables the door to be positioned on
any side wall
Workshop upgrade to include 4' wide
fully framed boxed door
Felt options

Potting Shed



STANDARD FEATURES

3" x 2" Framed roof
Full length slatted staging under window
Stable door
Opening window in one end

SPECIFICATION

Sizes from:
1.83m x 1.83m (6' x 6') to
3.05m x 2.44m (10' x 8')
Eaves ht. 73" / 1854mm
Ridge ht. 81" / 2058mm
Door 1765mm x 762mm
Windows 6' - 1530 x
1200mm

8' - 2160mm x 1200mm
10' - 2750mm x 1200mm
Framing 38mm x 50mm
Cladding 16mm x 125mm

OPTIONS AVAILABLE

Toughened glass
22mm premier cladding
50mm x 50mm Framing
22mm floor boards
Door available at either end of building
Felt options

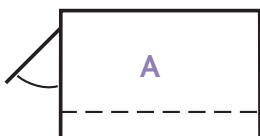

Combi-Potting Shed



STANDARD FEATURES

3" x 2" Framed roof
Full length slatted staging under window
Stable door
Opening window in one end
Integrated 4ft wide storage room with access via internal sliding door
2 - 4ft parallel shelves in storage room
Profiled fascias

SPECIFICATION

Sizes from 1.83m x 2.44m (6' x 8') to 3.05m x 3.05m (10' x 10')
Eaves height 2112mm / 83"

Ridge height 2307mm / 91"
Stable door
1765mm x 762mm
Internal sliding door
1810mm x 762mm
Windows 6' - 1530mm x
1200mm / 8' - 2160mm x
1200mm / 10' - 2750mm x
1200mm
Framing 50mm x 50mm
Cladding 16mm x 125mm

OPTIONS AVAILABLE

Toughened glass
22mm Premier cladding
50mm x 50mm Framing
22mm Floor boards
Door available at either end
Felt options

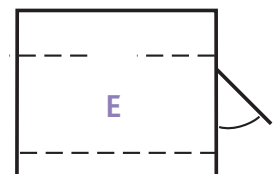
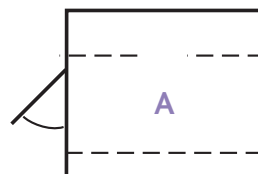



Sunflower

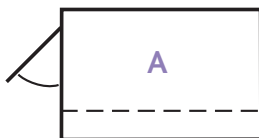

STANDARD FEATURES

- 3" x 2" Framed roof
- Full length slatted staging under window
- Full height windows returning at both ends
- Two joinery opening windows

SPECIFICATION

- Sizes from:
- 1.83m x 1.83m (6' x 6')
- to
- 3.05m x 2.44m (10' x 8')
- Eaves ht. 73" / 1860mm
- Ridge ht. 81" / 2057mm
- Door 1765mm x 762mm

- Windows 6' - 1645mm x 905mm
- 8' - 2220mm x 905mm
- 10' - 2805mm x 905mm
- Framing 38mm x 50mm
- Cladding 16mm x 125mm

OPTIONS AVAILABLE

- 22mm premier cladding
- 22mm floor boards
- 50mm x 50mm framing
- Stable door
- Door available at either end of building
- Felt options

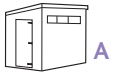

A

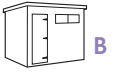

B

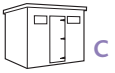

C



D

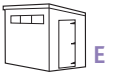

E



V



W



X



Y



Z



A



B



C



D



E

Security Apex and Pent

PENT



STANDARD FEATURES

Framing at 1'-300mm intervals throughout the sides for increased strength
38mm x 50mm diagonal bracing in gable ends
Galvanised bolted hinges
Security bolted padbolt protector
Internal glazed security window

APEX SPECIFICATION

Sizes from:
1.22m x 1.22m (4' x 4') to
3.66m x 2.44m (12' x 8')
Eaves ht. apex 1864mm
Ridge ht. apex 6' - 92" / 2350mm
8' - 97" / 2475mm
Door 1880mm x 762mm
Windows 1220mm x 150mm

Framing 38mm x 50mm
Door fully framed and braced in 50mm x 50mm framing
Cladding 16mm x 125mm

PENT SPECIFICATION

Eaves ht 76" / 1937mm
Ridge ht 84" / 2153mm
Door 1880mm x 762mm

OPTIONS AVAILABLE

50mm x 50mm framing
22mm premier cladding
22mm floor boards
3' Door
4' Double Doors
5' Double Doors
Door ramp
Felt options

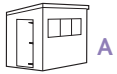

A



B



C



D



E



V



W



X



Y



Z



A



B



C

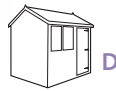

D



E



Heavy Duty Apex and Pent

PENT



STANDARD FEATURES

50mm x 50mm framing throughout with diagonal bracing
Substantial 75mm x 50mm roof truss:
1 up to 15ft
3 up to 20ft
5 up to 30ft
Heavy duty roofing felt
Joinery windows

APEX SPECIFICATION

Sizes from:
3.05m x 2.44m (10' x 8') to
9.14m x 3.66m (30' x 12')
Eaves ht. 1895mm
Ridge ht. 8' - 98" / 2490mm
10' - 102" / 2595mm
12' - 106" / 2690mm

Door 1880mm x 762mm
Windows 610mm x 457mm
Opening window 552mm x 400mm
Framing 50mm x 50mm
Cladding 16mm x 125mm

PENT SPECIFICATION

Eaves ht. 76" / 1937mm
Ridge ht. 84" / 2153mm
Door 1880mm x 762mm

OPTIONS AVAILABLE

22mm premier cladding
22mm floor boards
4', 5', 6' or 7' double doors
Security options
Felt options



Garage

STANDARD FEATURES

50mm x 50mm framing throughout with diagonal side bracing
 Substantial 75mm x 50mm roof truss:
 1 up to 15ft
 3 up to 20ft
 5 up to 30ft
 Heavy duty roofing felt
 Joinery windows

12' - 106" / 2690mm
 Double Doors 1880mm x 2135mm
 Side Door 1775mm x 762mm
 All doors are in 75mm x 50mm framing and braced
 Windows 610mm x 457mm
 Opening window 552mm x 400mm
 Framing 50mm x 50mm
 Cladding 16mm x 125mm

SPECIFICATION

Sizes from:
 3.05m x 2.44m (10' x 8') to
 9.14m x 3.66m (30' x 12')
 Eaves ht. 74" / 1895mm
 Ridge ht. 8' - 94" / 2490mm
 10' - 102" / 2595mm

OPTIONS AVAILABLE

22mm premier cladding
 4', 5', 6' or 7' fully framed 75mm x 50mm double doors
 With lock and key
 Security options
 Felt options



Pent Garage available on request



Rhino

STANDARD FEATURES

- 75mm x 50mm Fully framed door
- Roof constructed of 75mm x 50mm framing
- Door can be positioned at any side or end wall
- Mortice lock and key with antique handles
- 30" fully framed boxed door and fully boarded both sides
- Heavy duty hinges
- 75mm x 50mm framed roofing truss
- 3 fixed windows
- Heavy duty felt

APEX SPECIFICATION

- Sizes from 2.44m x 1.83m (8' x 6') up to 3.66m x 2.44m (12' x 8')
- Eaves height 1.864mm

Ridge height

- 4' – 86" / 2190mm
- 5' – 89" / 2260mm
- 6' – 92" / 2336mm
- 8' – 97" / 2475mm
- Door 1880mm x 762mm
- Windows 610mm x 457mm
- Framing 75mm x 50mm
- Cladding 16mm x 125mm

PENT SPECIFICATION

- Eaves height 76" / 1937mm
- Ridge height 85" / 2153mm

OPTIONS AVAILABLE - Apex & Pent

- 22mm Premier Cladding
- 19mm Log Lap Cladding
- 22mm Floor boards
- Felt options
- Larger sizes available upon request

PENT



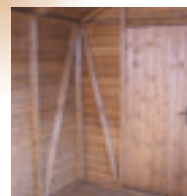

The Groundsman

STANDARD FEATURES

4ft double doors boarded both sides,
75mm x 50mm fully framed
Roof constructed of 75mm x 50mm
framing
Doors can be positioned on any side
or end wall
Diagonal bracing to sides and ends
Mortice lock and key with antique
handles
Heavy duty hinges
75mm x 50mm Framed roof truss
Joinery windows
Untreated workbench (h) 825mm x
(w) 1850mm x (d) 635mm
Heavy duty felt

APEX SPECIFICATION

Sizes from 2.44m x 1.83m (8' x 6') up
to 3.66m x 2.44m (12' x 8')

Eaves height. 1.864mm
Ridge height:
4' - 86" / 2190mm
5' - 89" / 2260mm
6' - 92" / 2336mm
8' - 97" / 2475mm
Door 1880mm x 1220mm
2 fixed windows 610mm x 457mm
1 opening window 552mm x 400mm
Framing 75mm x 50mm
Cladding 16mm x 125mm

PENT SPECIFICATION

Eaves height 76" / 1937mm
Ridge height 85" / 2153mm

OPTIONS AVAILABLE - Apex & Pent

22mm Premier Cladding
19mm Log Lap Cladding
22mm Floor boards
Felt options
Larger sizes available upon request



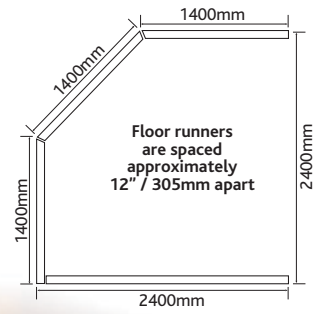
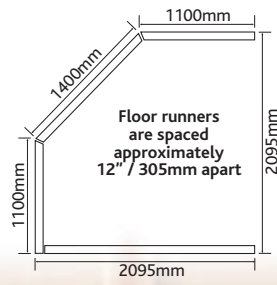
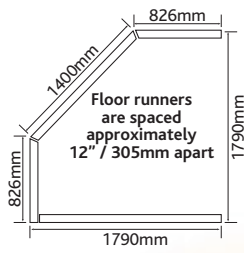

Corner Cabin

STANDARD FEATURES

3' wide door ledged and braced
 50mm x 50mm door with rim lock,
 door knob and 16" zinc coated door
 hinges
 Joinery opening windows

SPECIFICATION

Eaves ht. 76" / 1937mm
 Ridge ht. 84" / 2153mm
 Door 1880mm x 914mm
 Windows 610mm x 457mm
 Framing 38mm x 50mm

OPTIONS AVAILABLE

22mm Premier cladding
 22mm floor boards
 50mm x 50mm framing
 4ft double doors on all sizes
 Felt options

Garden Store



SPECIFICATION

Size: 1.52m x 915mm (5'x3')

Eaves ht. 1610mm

Ridge ht. 1710mm

Door 1460mm x 762mm Braced with lock and key

Framing 38mm x 50mm

Cladding 16mm x 125mm

Roof can slope either way

OPTIONS AVAILABLE

Doors available in any position

22mm Premier cladding

22mm floor boards

Garden Tidy



SPECIFICATION

Size: 1.83m x 762mm (6' x 2'6")

Eaves ht. 1610mm

Ridge ht. 1710mm

Double doors 1460mm x 1320mm

Braced with lock and key

Framing 38mm x 50mm

Cladding 16mm x 125mm

Roof can slope either way

OPTIONS AVAILABLE

Doors available in any position

22mm Premier cladding

22mm floor boards

Garden Chest



STANDARD FEATURES

Hinged lid with hasp and staple
Sliding internal storage shelf

SPECIFICATION

Size: 1.52m x 610mm (5' x 2')
Eaves ht. 710mm
Ridge ht. 802mm
Framing 38mm x 50mm
Cladding 16mm x 125mm

Wheelie Bin Store



SPECIFICATION

Size: 2134mm x 915mm (7' x 3')
Eaves ht. 1555mm
Ridge ht. 1655mm
Slated Double Doors 1550mm x 937mm (x2)
Framing 38mm x 50mm
Cladding 16mm x 125mm (to sides and back)
Roof can slope either way
Tower bolt fitted to each door

No floor inside this building

OPTIONS AVAILABLE

22mm Premier cladding
19mm Log lap

Dog Kennel



SPECIFICATION

sizes: 1.22m x 915mm
(4' x 3')
1.22m x 1.22m (4' x 4')
eaves ht. 660mm
ridge ht. 940mm

hole size 380mm x 305mm
framing 38mm x 50mm
cladding 16mm x 125mm

Animal Arc



SPECIFICATION

2 Sliding hatches, one at
either end
4' x 3' 5" (at base) Run
with 13mm x 13mm
galvanised wire mesh
2'4 x 3' 5" (at base) Hut

with access hole
Size 1930mm x 1041mm
(6'4" x 3'5")
Ridge 1016mm / 40"
Doors 254mm x 279mm
Internal access hole height
190mm

Deluxe Apex Kennel



STANDARD FEATURES

4' x 6' kennel unit with floor
and access door with closing
bob hole
6' x 6' run with 50mm x 50mm
Galvanised weldmesh on
50mm x 50mm framing, with front
Access door
Run designed with bottom drainage
for easy cleaning

SPECIFICATION

Size: 3.05m x 1.83m (10' x 6')
Eaves ht. kennel 1780mm
Eaves ht. run 1832mm
Ridge ht. kennel 2250mm
Ridge ht. run 2305mm
Door in run 1757mm x 600mm
Door in kennel 1765mm x 604mm
Framing 50mm x 50mm
Cladding 16mm x 125mm

OPTIONS AVAILABLE

22mm premier cladding
19mm Log Lap cladding
22mm floorboards

Pent Kennel 6' and 8' run



STANDARD FEATURES

4' x 4' kennel with floor, front door and side with tower bolt
Dog access hole
Run made from 50mm x 50mm galvanised heavy duty wire mesh, on 50mm x 50mm framing,
Door with tower bolt

SPECIFICATION

Sizes: 3.05m x 1.22m (10' x 4') and 3.66m x 1.22m (12' x 4')
Eaves ht. 1433mm
Ridge ht. 1610mm
Doors 1455mm x 596mm
Framing kennel 38mm x 50mm
Framing run 38mm x 50mm and 50mm x 50mm
Cladding 16mm x 125mm

OPTIONS AVAILABLE

22mm premier cladding
19mm Log Lap cladding
22mm floorboards
Run on left side opposite to main picture
6' or 8' run



Hen House



STANDARD FEATURES

3' X 6' Hen house with raised floor and single door. Separate closing hen access door and ramp
3' x 6' run with 13mm x 13mm Galvanised weldmesh, and meshed door

SPECIFICATION

Size: 1.83m x 1.83m (6' x 6')
Eaves ht. 69¹/₄" / 1760mm
Ridge ht. 87³/₄" / 2230mm
Meshed door 610mm x 1760mm
Single door in Hen house 1460mm x 915mm
Hen house access door 485mm x 380mm
Ramp 315 x 750
Framing 50mm x 50mm
Cladding 16mm x 125mm

OPTIONS AVAILABLE

Attachable Nesting Box:
Size: 480mm x 1830mm (19" x 6")
Comprising of 3 nesting compartments each 585 mm x 355mm
Eaves ht. 31¹/₂" / 800mm
Ridge ht. 36¹/₂" / 927mm
22mm Premier cladding
19mm Log lap
22mm floorboards



Traditional Dutch Barn

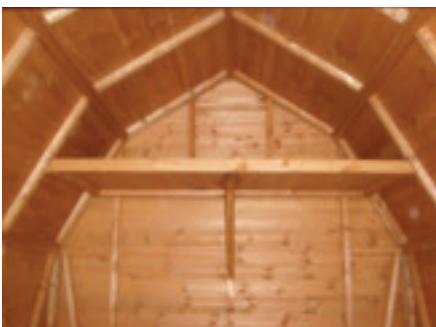

Internal roof and shelf

STANDARD FEATURES

Fully framed & braced 5ft barn style double doors
Door knob handle
Rim lock & key
One fixed window above door
Galvanised hinges
16mm x 125mm shiplap cladding
50mm x 50mm framing
1 internal shelf 33" wide
Green mineral felt (not shown in picture)
18' x 18" toughened glass

SPECIFICATION

Sizes available from 8ft x 6ft to 30ft x 10ft
Eaves height on all sizes 1680mm / 66"
Ridge height 6ft - 2605mm / 102"
Ridge height 8ft - 2980mm / 117"
Ridge height 10ft - 3355mm / 132"

Door size 5ft double doors barn style with 22mm tongue & grooved cladding
Fixed Georgian window size 18" x 18" / 460mm x 460mm
Framing 50mm x 50mm
Cladding 16mm x 125mm

OPTIONS AVAILABLE

Framing 75mm x 50mm
22mm Premier cladding (as shown in picture)
19mm Log lap
22mm heavy duty floor boards
Felt options including tiles (as shown in picture)
Joinery opening side windows
Additional fixed window in the rear apex
Security option on door
Additional shelving



Summer Cabin

STANDARD FEATURES

Roof overhang 1' / 305mm
Four diamond leaded windows
Stable door with ornate antique hinges
Rim lock and knob handle
Profiled fascia boards

SPECIFICATION

Sizes from: 1.52m x 2.13m (5' x 7') to
2.44m x 3.05m (8' x 10')
Eaves ht. 66" / 1680mm
Ridge ht. 6' - 85" / 2160mm
7' - 89" / 2270mm
8' - 90" / 2280mm
10' - 93" / 2370mm

Door 1765mm x 762mm
Windows 610mm x 457mm
Framing 38mm x 50mm
Cladding 16mm x 125mm

OPTIONS AVAILABLE

22mm premier cladding
19mm Log Lap Cladding
22mm floor boards
Veranda 2'6" or 4'
50mm x 50mm framing
Square leaded windows
Toughened glass
Felt options



The Althorpe

STANDARD FEATURES

Half Glazed arched top doors with antique hinges, ornate handle and lever lock
2 Arched top front fixed windows
Door Drip
Roof overhang 1' / 305mm

SPECIFICATION

Sizes: 1.52m x 2.13m (5x7) and
2.13m x 2.13m (7x7) only
Eaves height 73" / 1864mm
Ridge height 91" / 2312mm
Door 1790mm x 1103mm
Windows 445mm x 1010mm
Framing 38mm x 50mm
Cladding 16mm x 125mm

OPTIONS AVAILABLE

22mm Premier Cladding
19mm Log Lap cladding
22mm Heavy Duty Floor Boards
2'6" or 4' Veranda
Side window fixed or opening
Square or diamond leaded windows
Felt options



The Ascot

STANDARD FEATURES

Fully glazed plain glass double doors with antique hinges, ornate handle and lever lock

2 front fixed plain full length windows

2 side fixed plain full length windows

Roof overhang 1' / 305mm

Door drip

Profiled fascia boards

SPECIFICATION

Sizes from 1.83m x 2.44m (6'x8') to 3.66m x 3.66 (12' x 12')

Eaves height 72" / 1838mm

Ridge height 8' – 97" / 2466mm,

10' – 102" / 2580mm,

12' – 106" / 2700mm

Doors 1790mm x 1103mm

Windows 1622mm x 452mm

Framing 38mm x 50mm

Cladding 16mm x 125mm

OPTIONS AVAILABLE

Opening windows

22mm Premier cladding

19mm Log lap

22mm Floor boards

Toughened glass

50mm x 50mm Framing

2'6" or 4' Veranda

Felt options.



The Balmoral

STANDARD FEATURES

Half glazed joinery doors, with antique hinges, ornate handle and lever lock
4 front fixed windows
Roof overhang 1' / 305mm
Profiled fascia boards
Door drip

SPECIFICATION

Sizes from: 1.83m x 2.44m (6' x 8') to 3.66m x 3.66m (12' x 12')
Eaves ht. 73" / 1864mm
Ridge ht. 8' / 98" / 2490mm
10' - 101" / 2570mm
12' - 104" / 2655mm
Double doors 1790mm x 1103mm
Windows: 7' - 400mm x 400mm

Ridge ht. 8' - 553mm x 400mm
10' - 610 x 457mm
12' - 610 x 457mm
Framing 8' - 38mm x 50mm
10' - 38mm x 50mm
12' - 50mm x 50mm
Cladding 16mm x 125mm

OPTIONS AVAILABLE

22mm premier cladding
19mm Log Lap Cladding
22mm floor boards
Toughened glass
50mm x 50mm framing
2'6" or 4' veranda
Felt options



The Chatsworth

STANDARD FEATURES

Fully glazed Georgian double doors with antique hinges, ornate handle and lever lock

2 front fixed Georgian windows, if building is a 10ft front the 2 fixed windows become opening windows as standard

2 top hung opening

Georgian side windows

Roof overhang 1' / 305mm

Door drip

Profiled fascia boards

SPECIFICATION

Sizes from: 1.83m x 2.44m (6' x 8') to 3.66m x 3.66m (12' x 12')

Eaves ht. 73" / 1864mm

Ridge ht. 8' - 97" / 2466mm

10' - 102" / 2580mm

12' - 106" / 2700mm

Doors 1790mm x 1103mm

Windows 1010mm x 475mm

1040mm x 717mm

Framing 38mm x 50mm

Cladding 16mm x 125mm

OPTIONS AVAILABLE

22mm premier cladding

19mm Log Lap Cladding

22mm floor boards

Toughened glass

50mm x 50mm framing

2'6" or 4' veranda

Felt options



The Buckingham

STANDARD FEATURES

Fully glazed georgian door with antique hinges, ornate handle and lever lock

Georgian bay window

1 Georgian top hung opening side window

Roof overhang 1' / 305mm

Profiled fascias

Door drip

SPECIFICATION

Sizes from: 1.83m x 1.83m (6' x 8') to 3.66m x 3.66m (12' x 12')

Eaves ht. 73" / 1864mm

Ridge ht. 8' - 98" / 2490mm

10' - 101" / 2570mm

12' - 104" / 2655mm

Door 1790mm x 762mm

Windows 1040mm x 717mm

Bay window 1035mm x 1035mm

Framing 8' - 38 x 50mm

10' - 38mm x 50mm

12' front - 50mm x 50mm

Cladding 16mm x 125mm

OPTIONS AVAILABLE

22mm premier cladding

22mm floor boards

Toughened glass

50mm x 50mm framing

19mm Loglap Cladding

2'6" or 4' veranda

Mirror image available

Felt options



The Windsor

STANDARD FEATURES

Fully glazed georgian double doors, antique hinges, ornate handle and lever lock

Georgian bay window

2 Georgian top hung opening side windows

Roof overhang 1' / 305mm

Side wings 305mm

Profiled fascias

Door drip

SPECIFICATION

Sizes from: 1.83m x 3.05m (6' x 10') to 3.66m x 3.66m (12' x 12')

Eaves ht. 73" / 1864mm

Ridge ht. 10' - 101" / 2570mm

12' - 104" / 2655mm

Double doors 1790mm x 1103mm

Windows 1040mm x 717mm

Bay window 1035mm x 1035mm

Framing 10' - 38mm x 50mm

12' front - 50 x 50mm

Cladding 16mm x 125mm

OPTIONS AVAILABLE

22mm premier cladding

19mm Log Lap Cladding

22mm floor boards

Toughened glass

50mm x 50mm framing

Mirror image available

Felt options



The Kensington

STANDARD FEATURES

Fully glazed georgian double doors with antique hinges, ornate handle and lever lock
2 Georgian front windows
8ft front has 6 pane fixed
10ft / 12ft front has 9 pane openers
2 Georgian opening side windows
Roof overhang 1' / 305mm
Side wings 305mm
Profiled fascias
Door drip

SPECIFICATION

Sizes from: 1.83m x 3.05m (6' x 10') to 3.66m x 3.66m (12' x 12')
Eaves ht. 73" / 1864mm

Ridge ht. 8' - 98" / 2490mm

10' - 101" / 2570mm

12' - 104" / 2655mm

Double doors 1790mm x 1103mm

Windows 1040mm x 717mm

Framing 8' - 38mm x 50mm

10' - 38mm x 50mm

12' front - 50mm x 50mm

Cladding 16mm x 125mm

OPTIONS AVAILABLE

22mm premier cladding

22mm floor boards

Toughened glass

50mm x 50mm framing

19mm Log Lap cladding (picture shown in loglap cladding), this is not a standard feature

Felt options



Wentworth

STANDARD FEATURES

- Fully glazed georgian doors with antique hinges, ornate handle and lever lock
- 2 Georgian fixed front windows
- 2 top opening georgian side windows
- 4' veranda with plant boxes and side wings
- Profiled fascia and veranda boards
- Door drip

SPECIFICATION

- Sizes from: 3.05m x 3.05m (10' x 10')
- to 4.87m x 3.66m (16' x 12')
- Eaves ht. 74" / 1891mm

- Ridge ht. 10' - 101" / 2560mm
- 12' - 104" / 2645mm
- Double doors 1790mm x 1510mm
- Windows 1010mm x 475mm
- 1040mm x 717mm
- Framing 50mm x 50mm
- Cladding 16mm x 125mm

OPTIONS AVAILABLE

- 22mm premier cladding
- 19mm Log Lap Cladding
- 22mm floor boards
- Toughened glass
- Felt options



The Elton Home Office

STANDARD FEATURES

Georgian half glazed door with arched inserts to accommodate double glazed units (not included)
Heavy duty bolted black door hinges
Door drip

Georgian opening windows with arched inserts to accommodate double glazed units (not included)

Roof overhang 1' / 305mm
75mm x 50mm framing to sides and ends and braced
Profiled fascias

SPECIFICATION

Sizes from: 2.44m x 3.05m (8' x 10')
to
4.87m x 3.66m (16' x 12')
Eaves ht. 82" / 2088mm

Ridge ht. 10' - 110" / 2790mm
12' - 113" / 2865mm
Door 1990mm x 762mm
Front window 1000mm x 1043mm
Side window 1413mm x 1043mm
Framing 75mm x 50mm
Cladding 16mm x 125mm

OPTIONS AVAILABLE

22mm premier cladding
19mm Log Lap cladding
22mm floorboards
Additional side window
Double glazing
Toughened glass
Mirror image available
Felt options

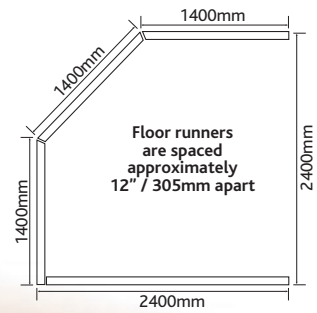
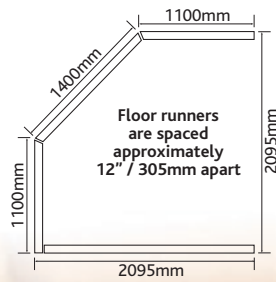
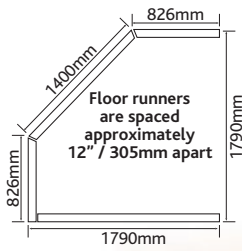

Corner Summerhouse Georgian

STANDARD FEATURES

Fully glazed Georgian double doors with antique hinges, ornate handle and lever lock
2 Georgian top opening side windows
Door drip

SPECIFICATION

Sizes from: 1.83m x 1.83m (6' x 6')
2.13m x 2.13m (7' x 7')
2.44m x 2.44m (8' x 8')
Eaves ht. 76" / 1942mm
Ridge ht. 84" / 2146mm
Double doors 1790mm x 1103mm
Windows 1040mm x 717mm

Framing 38mm x 50mm
Cladding 16mm x 125mm

OPTIONS AVAILABLE

22mm premier cladding
19mm Log Lap Cladding
22mm floor boards
Toughened glass
50mm x 50mm framing
Felt options

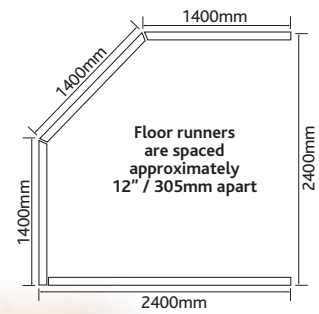
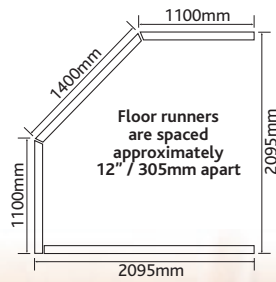
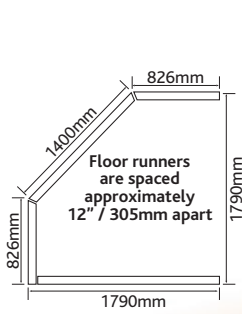

Corner Summerhouse Leaded

STANDARD FEATURES

Fully glazed double doors with leaded glass and antique hinges, ornate handle and lever lock

2 leaded glass top opening side windows

Door drip

SPECIFICATION

Sizes from: 1.83m x 1.83m (6' x 6')

2.13m x 2.13m (7' x 7')

2.44m x 2.44m (8' x 8')

Eaves ht. 76" / 1942mm

Ridge ht. 84" / 2146mm

Double doors 1790mm x 1103mm

Windows 1040mm x 717mm

Framing 38mm x 50mm

Cladding 16mm x 125mm

OPTIONS AVAILABLE

22mm cladding

19mm Log Lap Cladding

22mm floor boards

Toughened glass

50mm x 50mm framing

Felt options

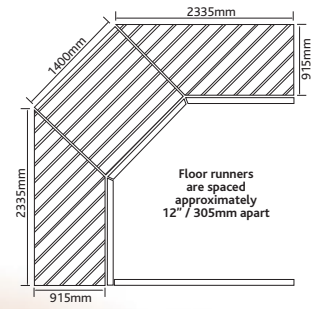
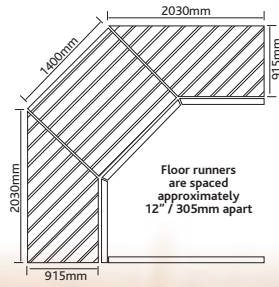
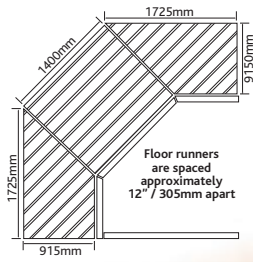

Blenheim Corner Summerhouse



Option available without upright supports

STANDARD FEATURES

- Fully glazed Georgian double doors
- Antique hinges
- Ornate handle with lever lock
- 2 top hung side windows

Door drip

Includes 3' veranda with roof overhang

Roof is boarded on the underside of veranda

SPECIFICATION

- Sizes available from 9ft x 9ft to 11ft x 11ft including 3ft veranda
- Eaves height 76" / 1942
- Ridge height 95" / 2410
- Doors 1790mm x 1103mm

- Windows either side of door, 6 pane on 9ft x 9ft, 9 pane on 10ft x 10ft & 11ft x 11ft
- Framing 38mm x 50mm
- Cladding 16mm x 125mm

OPTIONS AVAILABLE

- Diamond leaded, square leaded glazing or plain glazing
- 22mm premier cladding
- 22mm heavy duty floor boards
- 19mm log lap
- 50mm x 50mm framing
- 75mm x 50mm framing
- Toughened glass
- Felt options
- Profiled fascia boards
- Without upright supports



Pavilion

STANDARD FEATURES

Georgian double doors, antique hinges, ornate handle and lever lock

2 Georgian top hung 12 pane, opening side windows

2 front fixed Georgian windows

The front roof canopy is 485mm wide and tiled in red, green, black or slate tiles. The roof is felted with green roofing felt.

Profiled fascia boards

SPECIFICATION

Sizes from 2.44m x 1.83m (8x6) up to 3.05m x 2.44m (10x8)

Eaves height 77" / 1950mm

Ridge height 88" / 2170mm

Double doors 1790mm x 1103mm

Windows 1360mm x 718mm

Framing 38mm x 50mm

Cladding 16mm x 125mm

OPTIONS AVAILABLE

22mm premier cladding

19mm Log Lap cladding

22mm Heavy Duty floor

Toughened Glass

50mm x 50mm framing

Felt options



Pent Summerhouse

STANDARD FEATURES

Fully glazed Georgian double doors with antique hinges, ornate handle and lever lock
2 Georgian fixed front windows
2 Georgian 9 pane opening side windows
Profiled fascias
Door drip

SPECIFICATION

Sizes from: 1.52m x 2.44m (5' x 8') to 3.05m x 4.87m (10 x 16)
Eaves ht. 76" / 1937mm (back pent)
Ridge ht. 85" / 2153mm (front pent)
Double Doors 1790mm x 1103mm
Front windows 1010mm x 475mm
Side windows 1040mm x 717mm

Framing 38mm x 50mm
Cladding 16mm x 125mm

OPTIONS AVAILABLE

22mm Premier cladding
19mm Log lap cladding
22mm Floor boards
50mm x 50mm framing
2'6" veranda with fully tiled canopy in a choice of red, slate, green or black tiles
Toughened Glass
Choice of Georgian, diamond lead, or square lead glazing



Dual Pent Summerhouse

STANDARD FEATURES

Half glazed arch top double doors with antique hinges, ornate handle and lever lock
2 Arch top fixed front windows
2 Arch top opening side windows
Integrated 4' storage room with side access by security door
Galvanised bolted hinges & padbolt protector to side access door
Profiled fascias

SPECIFICATION

Sizes from: 1.83m x 2.44m (6' x 8') to 4.87m x 4.87m (16 x 16)
Eaves ht. 76" / 1937mm
Ridge ht. 85" / 2153mm
Security door 1867mm x 908mm fully framed and braced in 50mm x 50mm framing

Double Doors 1780mm x 1512mm (10' & above)
1780mm x 1103mm (8')
Front windows 445mm x 1010mm
Side windows 1040mm x 717mm
Framing 38mm x 50mm
Cladding 16mm x 125mm

OPTIONS AVAILABLE

22mm Premier cladding
19mm Log lap cladding
22mm Floor boards
2'6" veranda with fully tiled canopy in a choice of red, slate, green or black tiles
Toughened Glass
Choice of Georgian, diamond lead, or square lead glazing



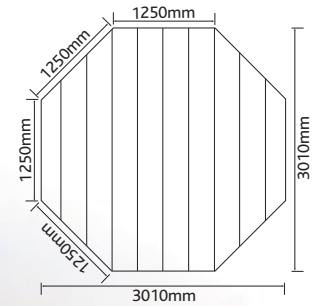
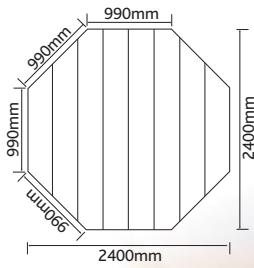

Octagonal 8 and 10

RED TILE



STANDARD FEATURES

Half glazed joinery single door with antique hinges, ornate handle and lever lock

2 fully glazed top hung windows

2 fully glazed fixed windows

All side panels of the same size are fully interchangeable upon installation

Choice of tiled roof in red, slate, green or black

Door drip

Choice of georgian, diamond lead, or square lead glazing

SPECIFICATION

Size: 8' x 8' / 2440mm x 2440mm

Eaves ht. 80" / 2035mm

Ridge ht. 99" / 2535mm

Door 1790mm x 762mm

Windows 1040mm x 717mm

Framing 38mm x 50mm

Cladding 16mm x 125mm

OCTAGONAL 10 SPECIFICATION

size: 10' x 10' / 3050mm x 3050mm

Eaves ht. 80" / 2035mm

Ridge ht. 99" / 2535mm

Double doors 1790mm x 1103mm

OPTIONS AVAILABLE

22mm premier cladding

19mm Log Lap cladding

22mm floorboards

Toughened glass

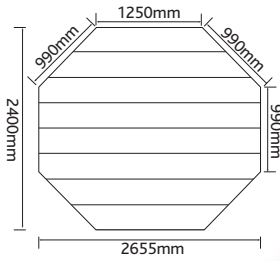

Stretched Octagonal 8

STANDARD FEATURES

- Half glazed double doors with antique hinges, ornate handle and lever lock
- 2 fully glazed top hung windows
- 2 fully glazed fixed windows
- Choice of tiled roof in red, slate, green or black
- Door drip
- Choice of Georgian, diamond lead, or square lead glazing

SPECIFICATION

- size: 8' x 8'9" / 2440mm x 2667mm
- Eaves ht. 80" / 2035mm
- Ridge ht. 99" / 2535mm
- Door 1790mm x 1103mm
- Windows 1040mm x 717mm
- Framing 38mm x 50mm
- Cladding 16mm x 125mm

OPTIONS AVAILABLE

- 22mm premier cladding
- 19mm Log Lap cladding
- 22mm floorboards
- Toughened glass



The Sandringham

STANDARD FEATURES

Georgian double doors to accommodate double glazing, antique hinges, ornate handle and lever lock
2 Side 12 pane Georgian top hung opening windows to accommodate double glazing
2 Front 12 pane Georgian fixed windows to accommodate double glazing
The hipped roof comes with a choice of coloured felt tiles (not fitted)
Heavy duty 3" x 2" framing throughout
Toughened glass

SPECIFICATION

Size 3.05m x 3.05 (10' x 10')
Eaves height 2160mm / 85"
Ridge height 3416mm / 136"
Double doors 1790mm x 1103mm
Windows 1360mm 718mm
Framing 75mm x 50mm
Cladding 16m x 125mm

OPTIONS AVAILABLE

22mm Premier cladding
19mm Log lap cladding
22mm Heavy duty floor
Coloured felt tiles with choice of Red, Green, Slate and Black
Double glazed units
Door and window options, plain, leaded and folding



Toddlers Retreat

STANDARD FEATURES

Two side windows with acrylic
Door window Square acrylic
Profiled fascias
Antique door handle and hinges with
adjustable door catch

SPECIFICATION

Size: 4' X 4' (1.2m x 1.2m)
Eaves ht. 42¹/₄" (1074mm)
Ridge ht. 54¹/₂" (1384mm)
Door 1074mm x 596mm
Side windows 457mm x 457mm
Door window 305mm x 305mm
Framing 38mm x 50mm
Cladding 16mm x 125mm

OPTIONS AVAILABLE

22mm Premier cladding
19mm Log lap
Window Box
2' veranda



My Little Den

STANDARD FEATURES

Door with diamond window, antique hinges and handle with adjustable door catch

2 acrylic Georgian windows

Roof overhang 1' / 305mm

Profiled fascias

SPECIFICATION

Sizes from: 1.22m x 1.83m (4' x 6') to 2.44m x 1.83m (8' x 6')

Eaves ht. 51" / 1318mm

Ridge ht. 73" / 1850mm

Door 1282mm x 596mm

Windows 457mm x 457mm

Framing 38mm x 50mm

Cladding 16mm x 125mm

OPTIONS AVAILABLE

22mm premier cladding

19mm Log Lap cladding

22mm floorboards

Window box

2' veranda (with or without) please specify

Additional fixed side window

Felt options



Ladybird Cottage

STANDARD FEATURES

Georgian joinery door with antique hinges and handle, with adjustable door catch

4 acrylic Georgian windows

Roof overhang 1' / 305mm

Profiled fascia boards

SPECIFICATION

Sizes from: 1.52m x 2.13m (5' x 7') to 2.74m x 2.13m (7' x 7')

Eaves ht. 49" / 1255mm

Ridge ht. 70" / 1790mm

Door 1180mm x 535mm

Windows 457mm x 457mm

Framing 38mm x 50mm

Cladding 16mm x 125mm

OPTIONS AVAILABLE

22mm premier cladding

19mm Log Lap cladding

22mm floorboards

2' verandah (with or without)
please specify

Felt options



Snowdrop Cottage

STANDARD FEATURES

Antique hinges and handle with adjustable door catch

4 acrylic Georgian windows

Georgian joinery door with antique hinges and handle with adjustable door catch

Chimney pot

Hip roof

Profiled fascia boards

SPECIFICATION

Sizes: 1.83m x 1.22m (6' x 4') and 2.13m x 1.52m (7' x 5')

Eaves ht. 51" / 1318mm

Ridge ht. 4' - 63" / 1615mm

5' - 70" / 1790mm

Door 1180mm x 535mm

Windows 457mm x 457mm

Framing 38mm x 50mm

Cladding 16mm x 125mm

OPTIONS AVAILABLE

22mm premier cladding

19mm Log Lap cladding

22mm floorboards

Felt options



Escape

STANDARD FEATURES

Full size door with 10" diamond window, antique hinges and handle
Internal bunk bed with safety rail, ladder and hand rail
1 Acrylic Georgian window
1 Window box
Profiled fascias

OPTIONS AVAILABLE

22mm Premier cladding
19mm Log lap cladding
22mm Floor boards
Additional side windows
Mirror image available
Felt options

SPECIFICATION

Size 2.44m x 1.83m (8' x 6')
Eaves 1964mm / 77"
Ridge 2436 / 96"
Door 1765mm x 762mm
Window 457mm x 457mm
Framing 38mm x 50mm
Cladding 16mm x 125mm





Wilton Lodge

STANDARD FEATURES

- Door with diamond window, antique hinges and handle, with adjustable catch
- 3 acrylic Georgian windows with large window box
- Roof overhang 1' / 305mm
- Internal bunk bed with safety rail
- Ladder with hand rail
- Profiled fascias

SPECIFICATION

- Sizes from: 1.52m x 2.13m (5' x 7') to 2.74m x 2.13m (9' x 7')
- Eaves ht. 56" / 1435mm to 70" / 1785mm

- Ridge ht. 93" / 2350mm
- Door 1410mm x 596mm
- Windows 457mm x 457mm
- Framing 38mm x 50mm
- Cladding 16mm x 125mm

OPTIONS AVAILABLE

- 22mm premier cladding
- 19mm Log Lap cladding
- 22mm floorboards
- Side fixed windows
- 2' veranda (with or without) please specify
- Mirror image available
- Felt options





Candy Cabin

STANDARD FEATURES

Stable door with diamond in the top
 Antique hinges and handle with adjustable closing catch
 2 acrylic Georgian windows
 1 window box
 Internal bunk bed with safety rail, ladder with hand rail
 Profiled fascias
 Roof overhang 1' / 305mm

SPECIFICATION

sizes: 1.83m x 2.44m (6' x 8') and 2.44m x 2.44m (8' x 8')
 Eaves ht. 56" / 1435mm to 70" / 1785mm
 Ridge ht. 93" / 2360mm

Stable door:

Top 678mm x 596mm
 Bottom 730mm x 596mm
 Windows 457mm x 457mm
 Framing 38mm x 50mm
 Cladding 16mm x 125mm

OPTIONS AVAILABLE

22mm premier cladding
 19mm Log Lap cladding
 22mm floorboards
 Side fixed window
 Window box
 Mirror image available
 2' veranda (with or without) please specify
 Felt options





The Hideaway

STANDARD FEATURES

Single and double garage doors with diamond windows, complete with antique hinges and handles
2 acrylic Georgian windows
2 window boxes
Internal bunk bed with safety rail, ladder with hand rail
Profiled fascias
Roof overhang 1' / 305mm

SPECIFICATION

sizes: 1.52m x 3.05m (5' x 10')
and 1.83m x 3.05m (6' x 10')
Eaves ht. 56" / 1435mm to
70" / 1785mm
Ridge ht. 96" / 2430mm

Single door 1410mm x 596mm
Double door 1042mm x 1158mm
Windows 457mm x 457mm
Framing 38mm x 50mm
Cladding 16mm x 125mm

OPTIONS AVAILABLE

22mm premier cladding
19mm Log Lap cladding
22mm floorboards
Additional side windows
Mirror image available
Felt options





Charleys Castle

STANDARD FEATURES

Door with antique hinges, handle and adjustable door catch
 Diamond window in door
 3 front acrylic Georgian windows
 1 side acrylic Georgian window
 Profiled fascias and veranda boards
 2'6" veranda with front returns
 Twin level upper bunk with ladder and handrail

SPECIFICATION

Sizes: 2.59m x 3.05m (8'6" x 10') and 3.2m x 3.05m (10'6" x 10') including 2'6" verandah

Eaves ht. 66" / 1680mm
 Ridge ht. 110" / 2810mm
 Return veranda's 1070mm
 Door 1410mm x 596mm
 Windows 457mm x 457mm
 Framing 38mm x 50mm
 Cladding 16mm x 125mm

OPTIONS AVAILABLE

22mm premier cladding
 19mm Log Lap cladding
 22mm floorboards
 Side fixed window
 Felt options





Kids Club House

STANDARD FEATURES

Door with antique hinges and handle with adjustable door catch
Diamond window in door
4 acrylic Georgian windows
Profiled fascias and veranda boards
3' veranda with side returns
Functional dormer window
Interior with raised bunk and guard rails
Ladder with hand rail

SPECIFICATION

Sizes:
2.13m x 3.05m (7' x 10')
2.44m x 3.05m (8' x 10')
3.05m x 3.05m (10' x 10')

Eaves ht. 66" / 1680mm
Ridge ht. 110" / 2810mm
Door 1410mm x 596mm
Windows 457mm x 457mm
Framing 38mm x 50mm
Cladding 16mm x 125mm

OPTIONS AVAILABLE

22mm premier cladding
19mm Log Lap cladding
22mm floorboards
Side fixed windows
Felt options

